

Legacy DDR4, DDR3/L, & DDR2 SDRAM Part Numbering System

The part numbering system is available at www.micron.com/numbering

Legacy DDR4, DDR3/L, and DDR2 SDRAM

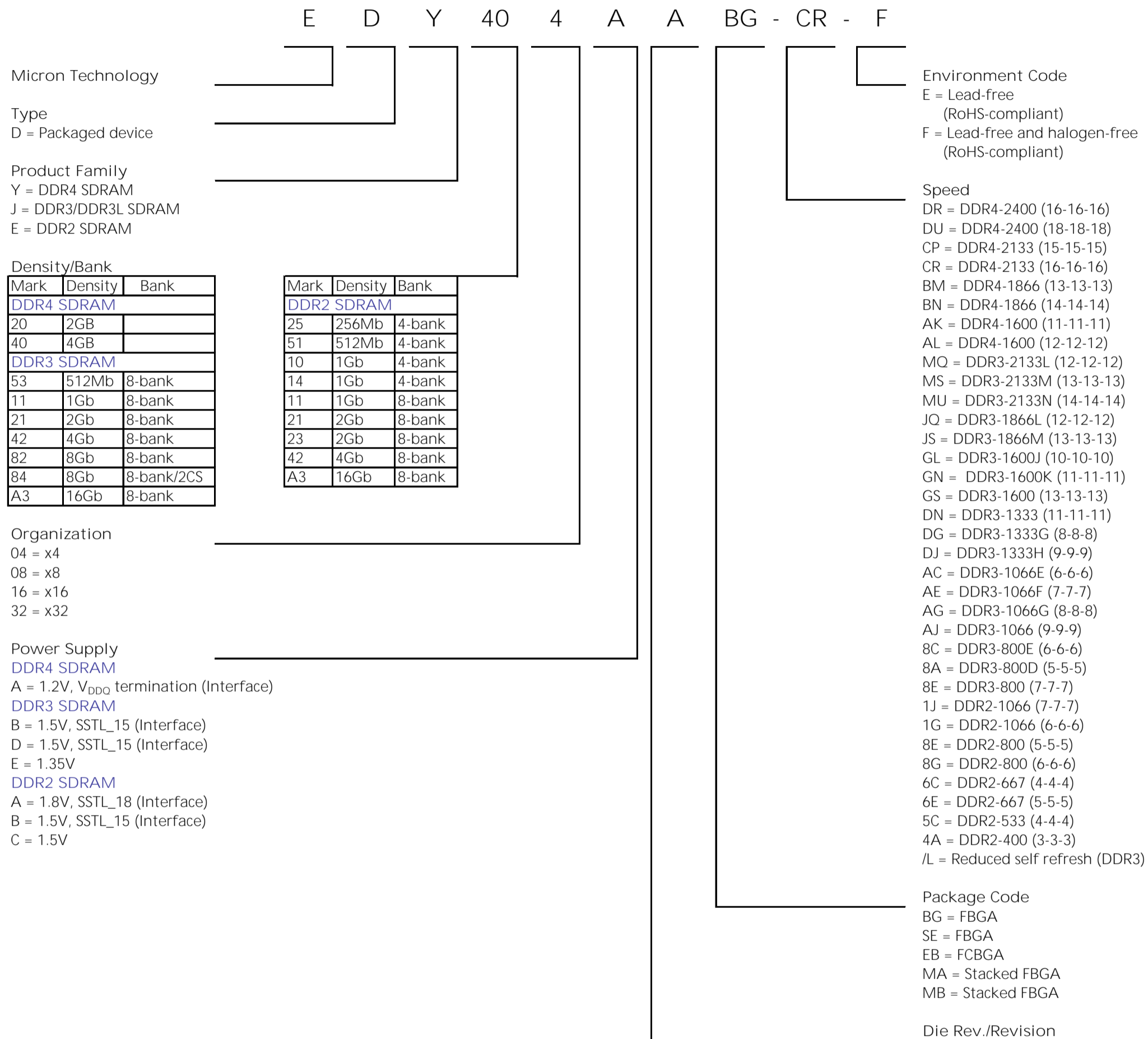

Rev. August 14, 2015

© 2015 Micron Technology, Inc.
Micron and the Micron logo are trademarks of Micron Technology, Inc.
Products and specifications are subject to change without notice. Dates are estimates only.



Legacy Graphics DRAM, RDRAM®, and XDR™ Part Numbering System

The part numbering system is available at www.micron.com/numbering

Legacy GDDR3, GDDR5, graphics DDR3, RDRAM, and XDR

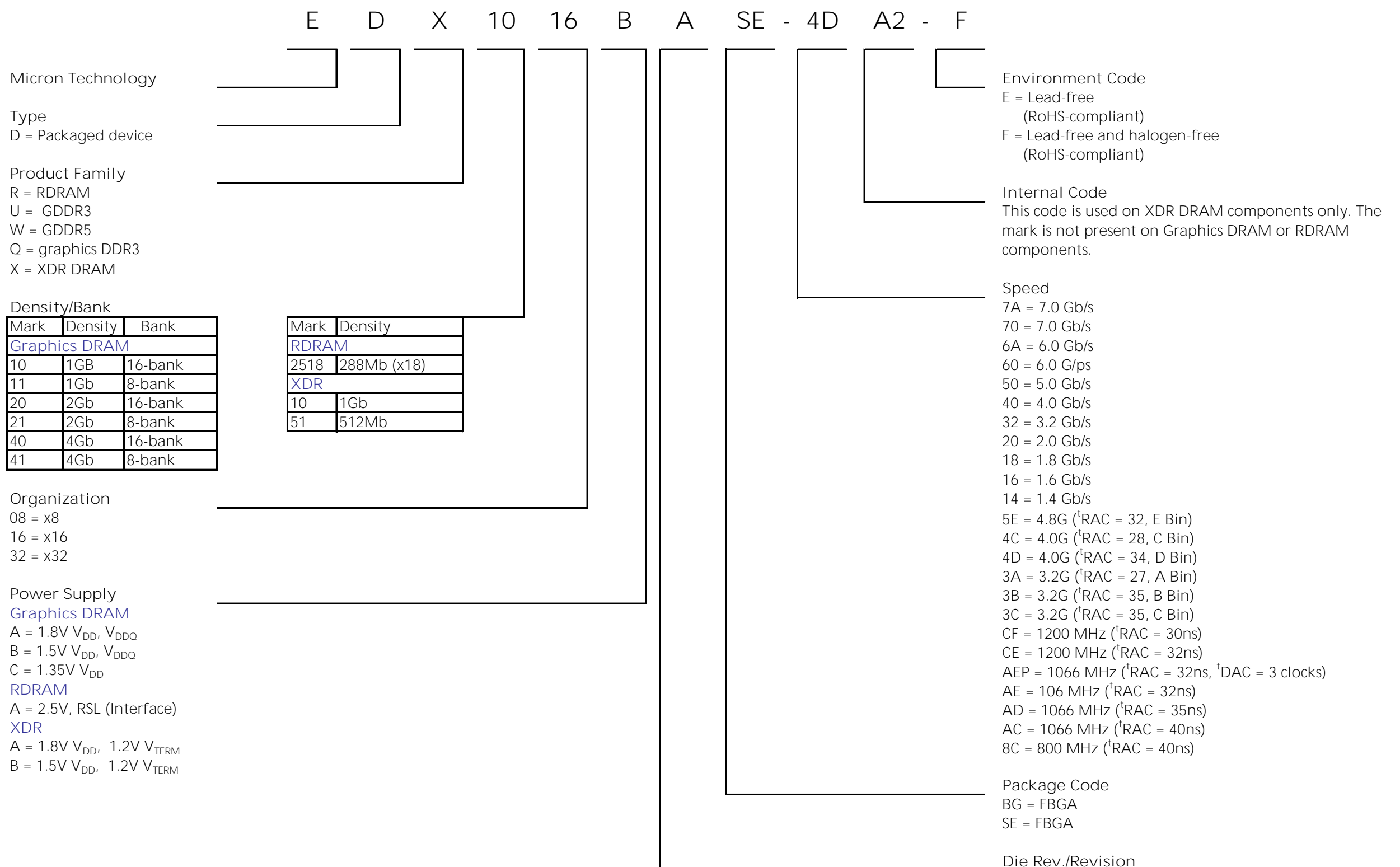

Rev. August 14, 2015

Rambus, RDRAM and the Rambus logo are registered trademarks of Rambus Inc.
Direct Rambus, Direct RDRAM, RIMM, SO-RIMM and QRSL are trademarks of Rambus Inc.

© 2015 Micron Technology, Inc.
Micron and the Micron logo are trademarks of Micron Technology, Inc.
Products and specifications are subject to change without notice. Dates are estimates only.



Legacy MCP Part Numbering System

The part numbering system is available at www.micron.com/numbering

Legacy Multichip Packages

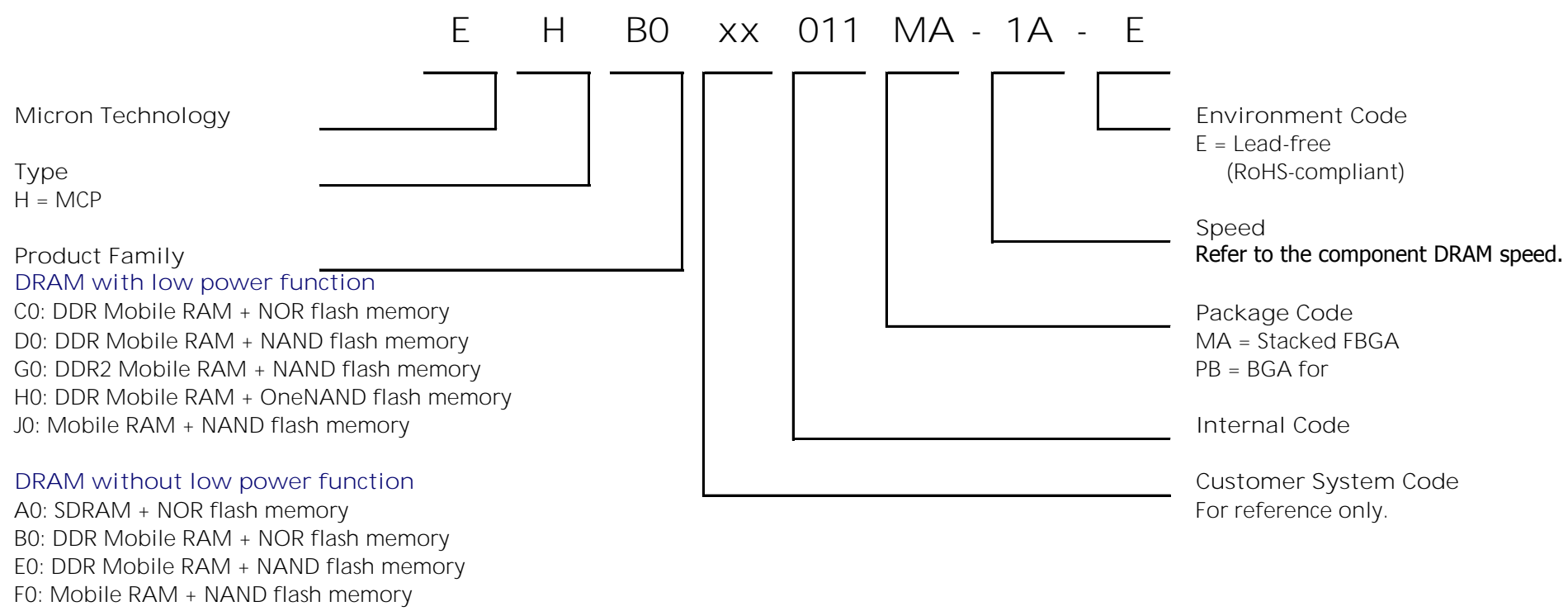

Rev. August 14, 2015

© 2015 Micron Technology, Inc.
 Micron and the Micron logo are trademarks of Micron Technology, Inc.
 Products and specifications are subject to change without notice. Dates are estimates only.



Legacy DDR4 Module Part Numbering System

The part numbering system is available at www.micron.com/numbering

Legacy DDR4 modules

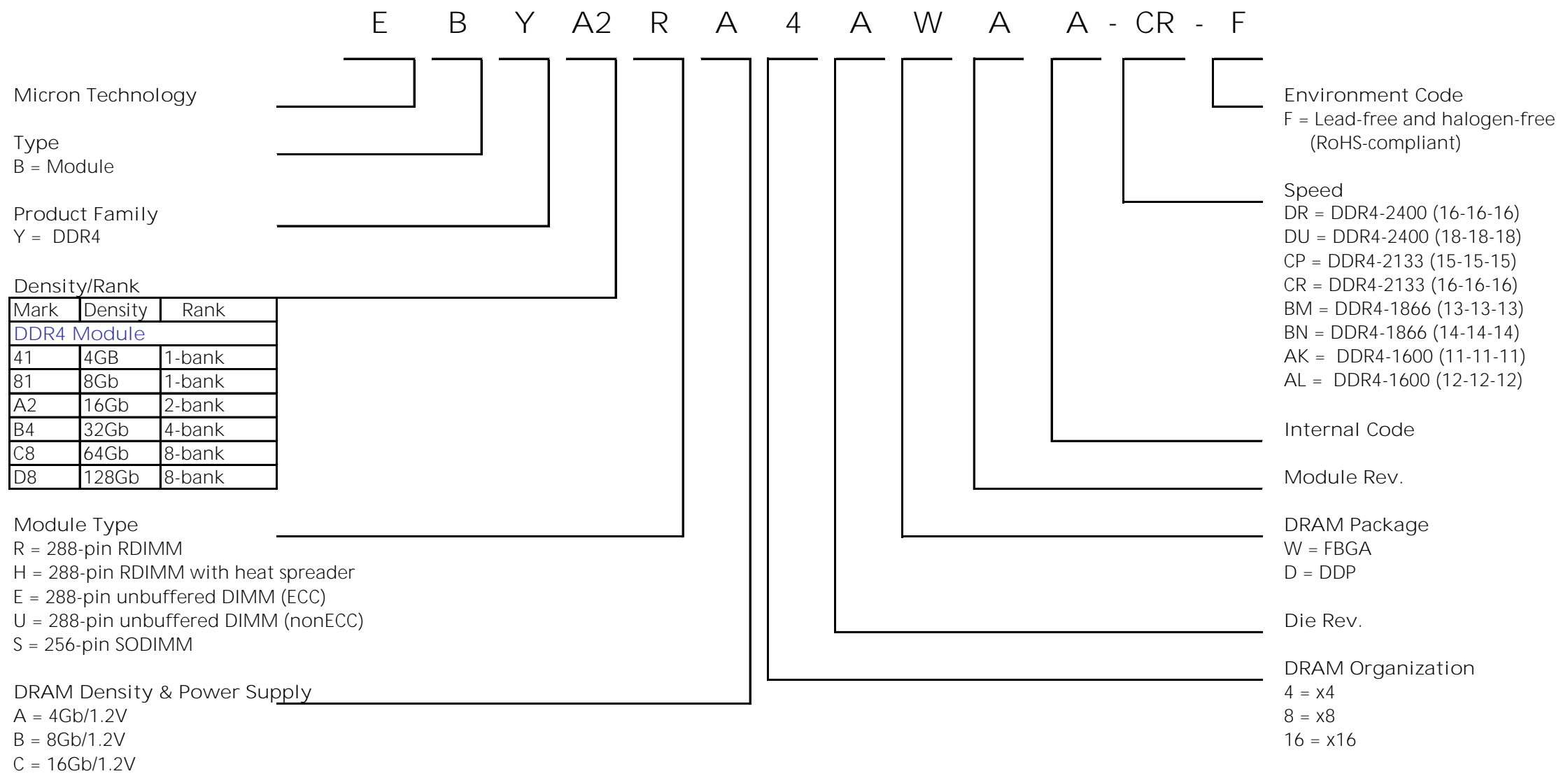

Rev. August 14, 2015

© 2015 Micron Technology, Inc.
Micron and the Micron logo are trademarks of Micron Technology, Inc.
Products and specifications are subject to change without notice. Dates are estimates only.



Legacy DDR3 Module Part Numbering System

The part numbering system is available at www.micron.com/numbering

Legacy DDR3 modules

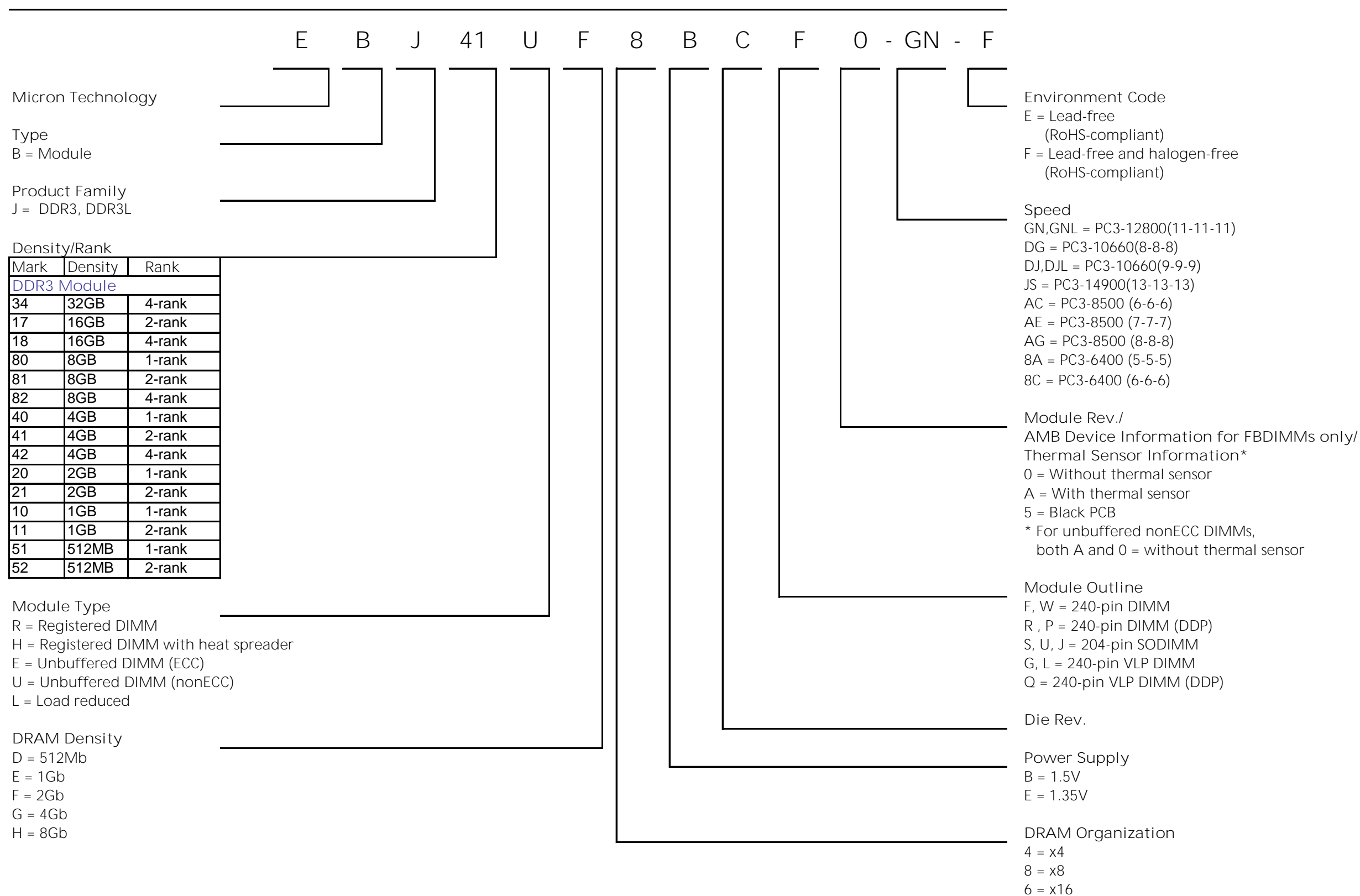

Rev. August 14, 2015

© 2015 Micron Technology, Inc.
Micron and the Micron logo are trademarks of Micron Technology, Inc.
Products and specifications are subject to change without notice. Dates are estimates only.



Legacy DDR2 Module Part Numbering System

The part numbering system is available at www.micron.com/numbering

Legacy DDR2 modules

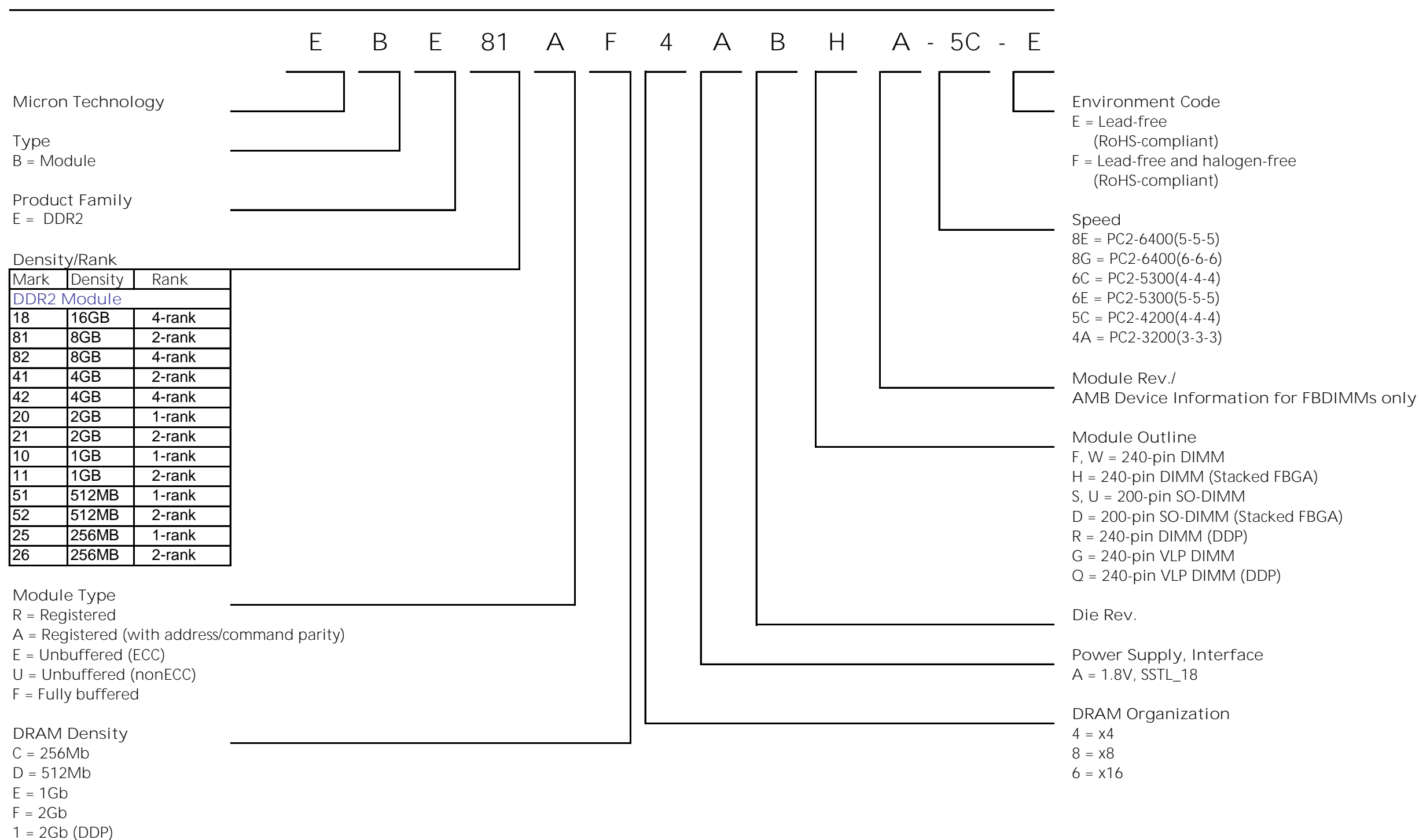

Rev. August 14, 2015

© 2015 Micron Technology, Inc.
Micron and the Micron logo are trademarks of Micron Technology, Inc.
Products and specifications are subject to change without notice. Dates are estimates only.



Legacy DDR Module Part Numbering System

The part numbering system is available at www.micron.com/numbering

Legacy DDR modules

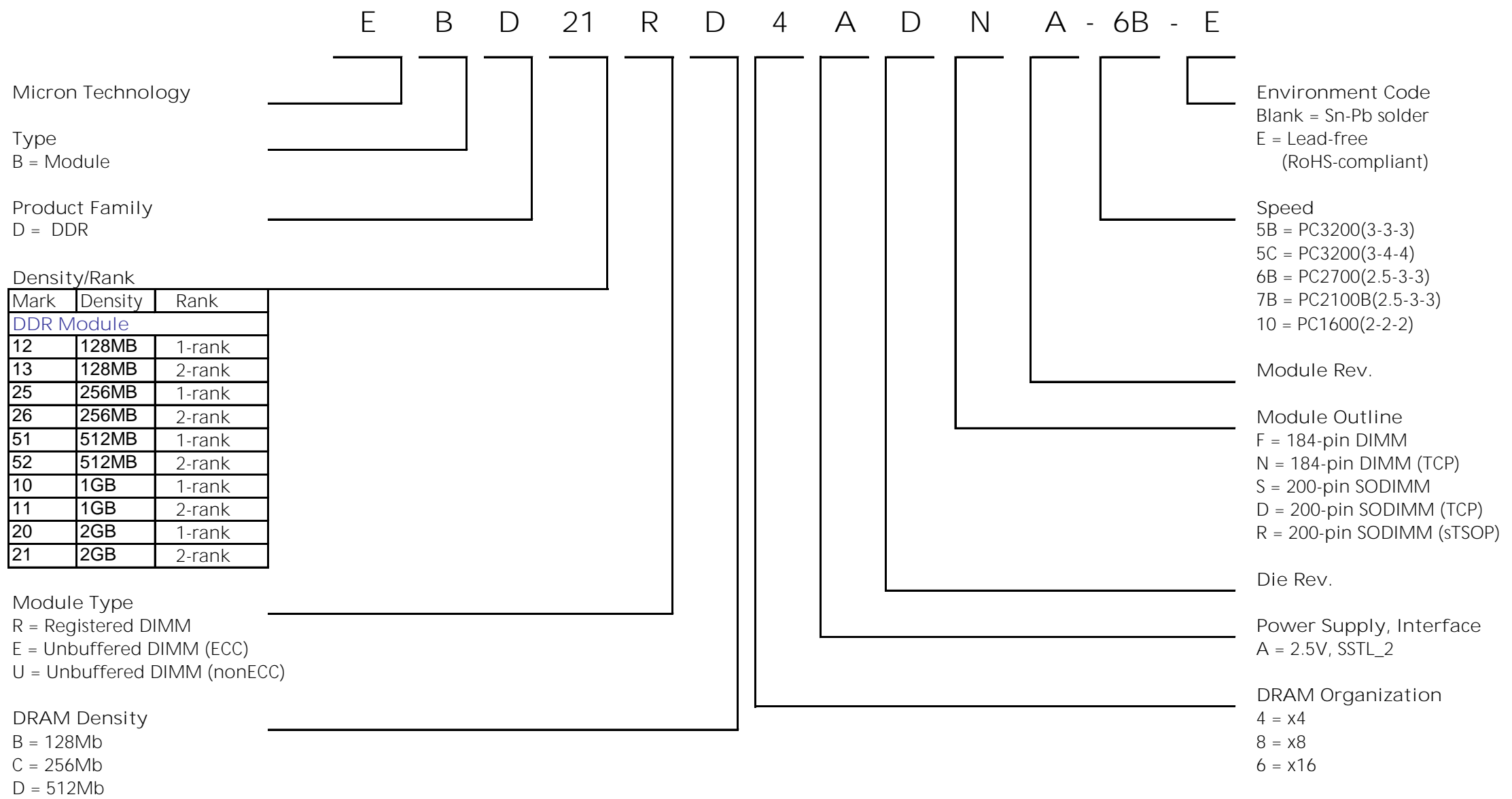

Rev. August 14, 2015

© 2015 Micron Technology, Inc.
Micron and the Micron logo are trademarks of Micron Technology, Inc.
Products and specifications are subject to change without notice. Dates are estimates only.



Legacy SDRAM Module Part Numbering System

The part numbering system is available at www.micron.com/numbering

Legacy SDRAM modules

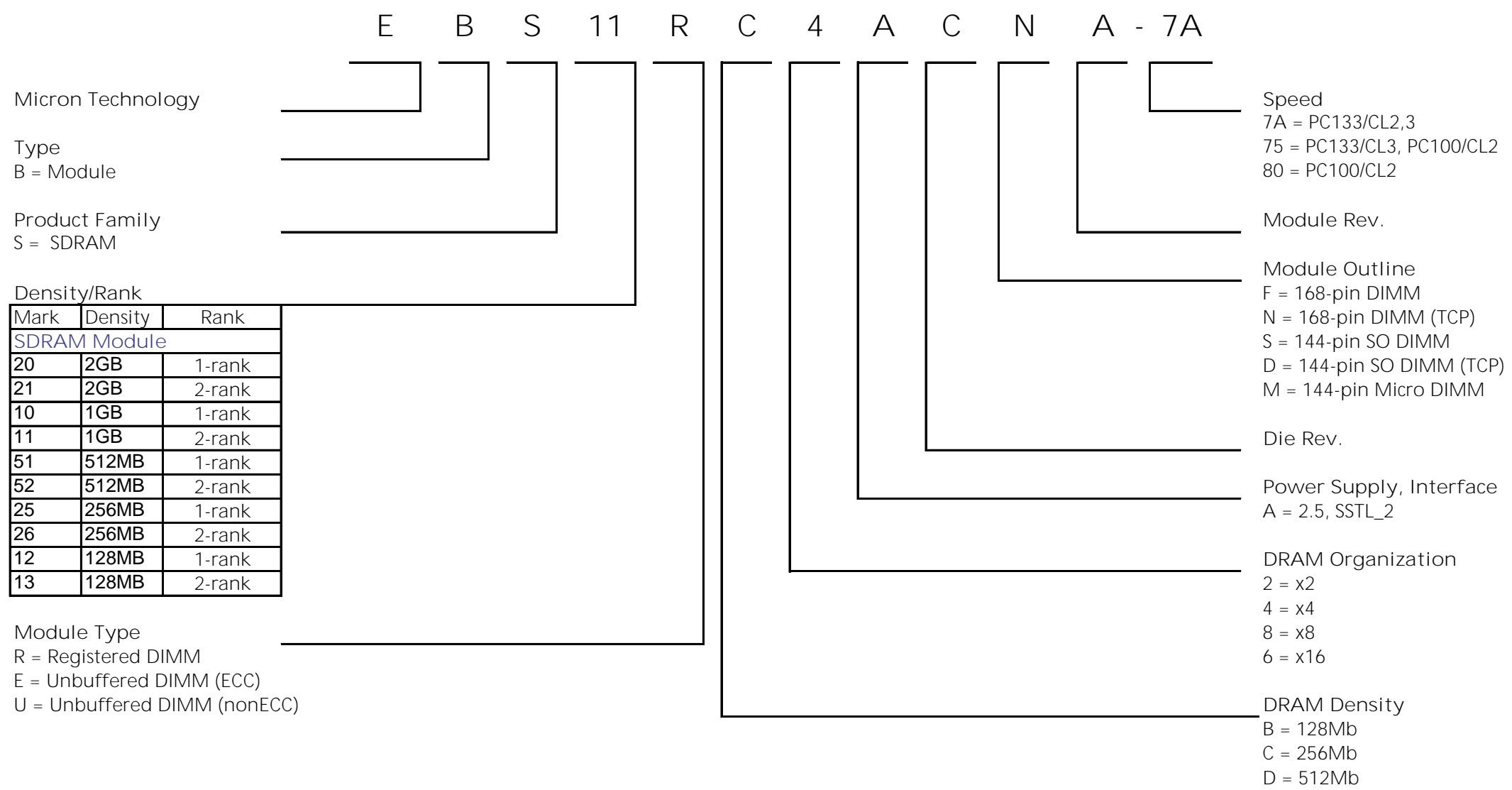

Rev. August 14, 2015

© 2015 Micron Technology, Inc.
Micron and the Micron logo are trademarks of Micron Technology, Inc.
Products and specifications are subject to change without notice. Dates are estimates only.



Legacy RIMM™ Part Numbering System

The part numbering system is available at www.micron.com/numbering

Legacy RIMM

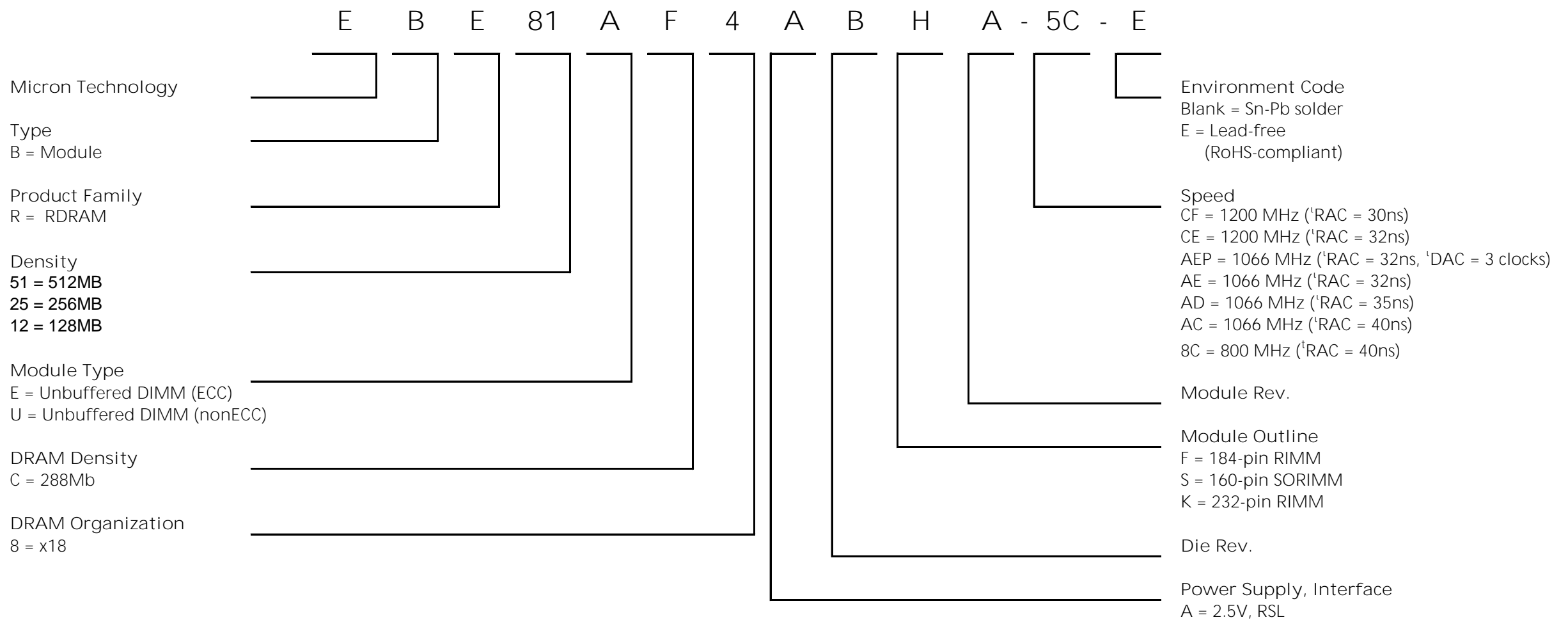

Rev. August 14, 2015

Rambus, RDRAM and the Rambus logo are registered trademarks of Rambus Inc.
Direct Rambus, Direct RDRAM, RIMM, SO-RIMM and QRSL are trademarks of Rambus Inc.

© 2015 Micron Technology, Inc.
Micron and the Micron logo are trademarks of Micron Technology, Inc.
Products and specifications are subject to change without notice. Dates are estimates only.



Legacy Mobile Bare Die Part Numbering System

The part numbering system is available at www.micron.com/numbering

Legacy Mobile Wide IO, LPDDR3, LPDDR2, Mobile RAM™

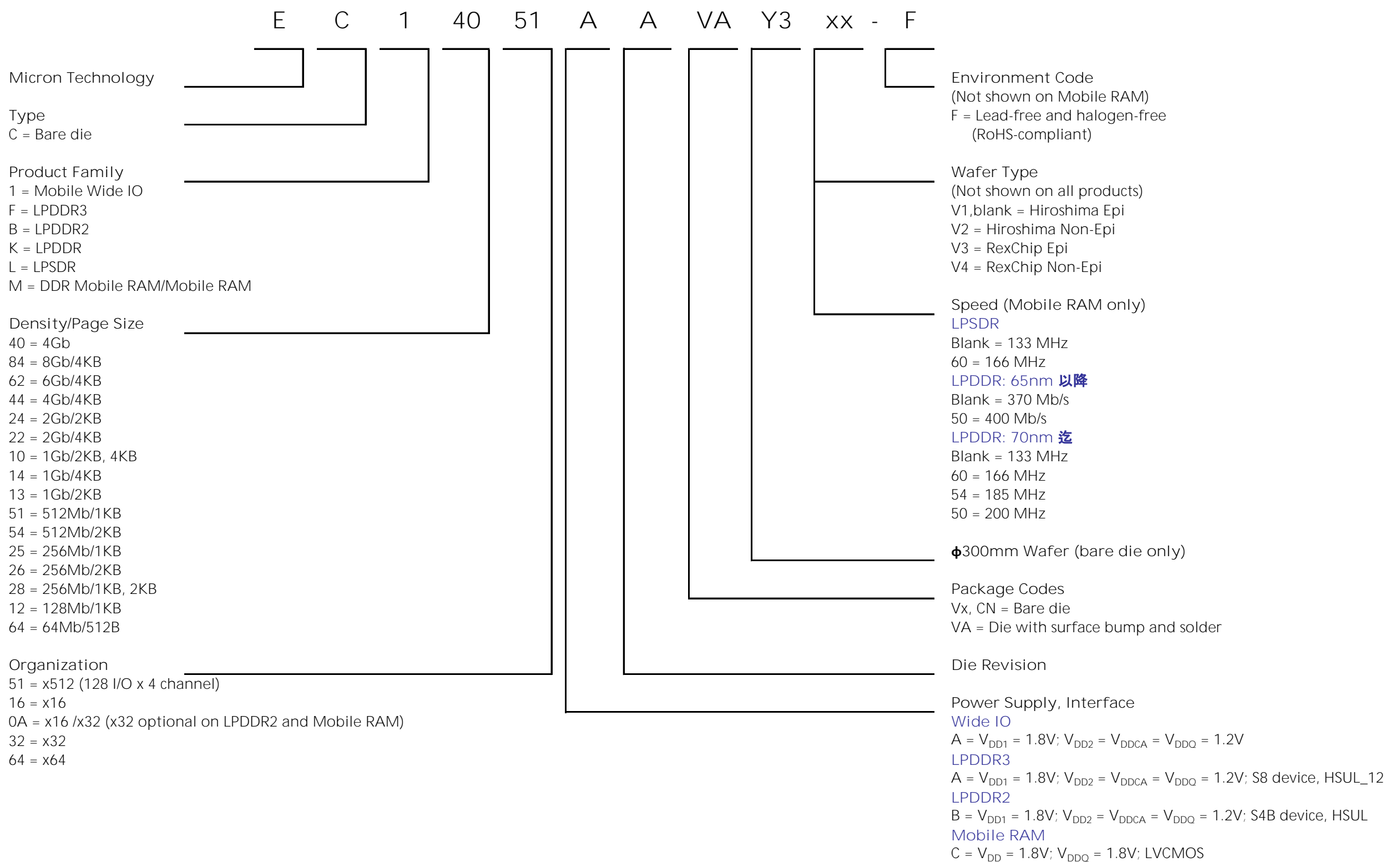

Rev. August 14, 2015

© 2014 Micron Technology, Inc.
Micron and the Micron logo are trademarks of Micron Technology, Inc.
Products and specifications are subject to change without notice. Dates are estimates only.



Legacy LPDRAM Part Numbering System

The part numbering system is available at www.micron.com/numbering

Legacy LPDDR3 PoP

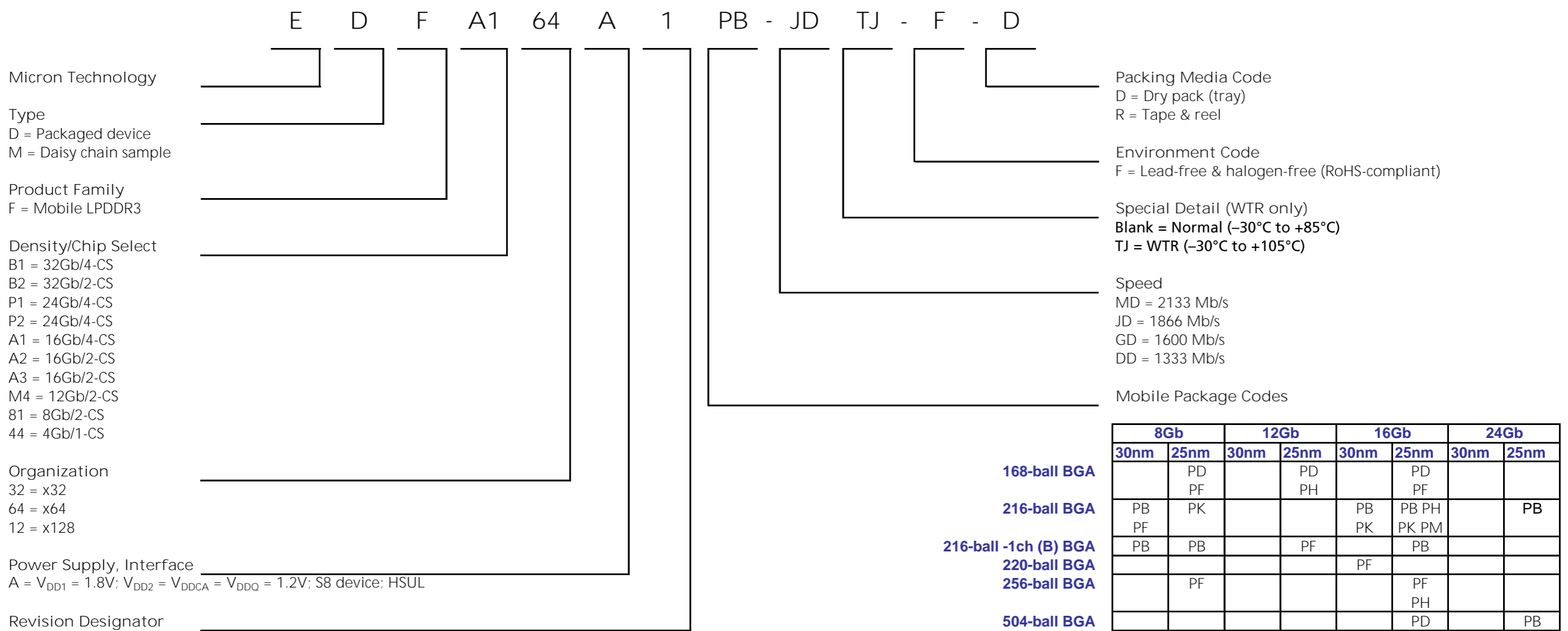

Rev. August 14, 2015

© 2014 Micron Technology, Inc.
 Micron and the Micron logo are trademarks of Micron Technology, Inc.
 Products and specifications are subject to change without notice. Dates are estimates only.



Legacy LPDRAM Part Numbering System

The part numbering system is available at www.micron.com/numbering

Legacy LPDDR3 FBGA

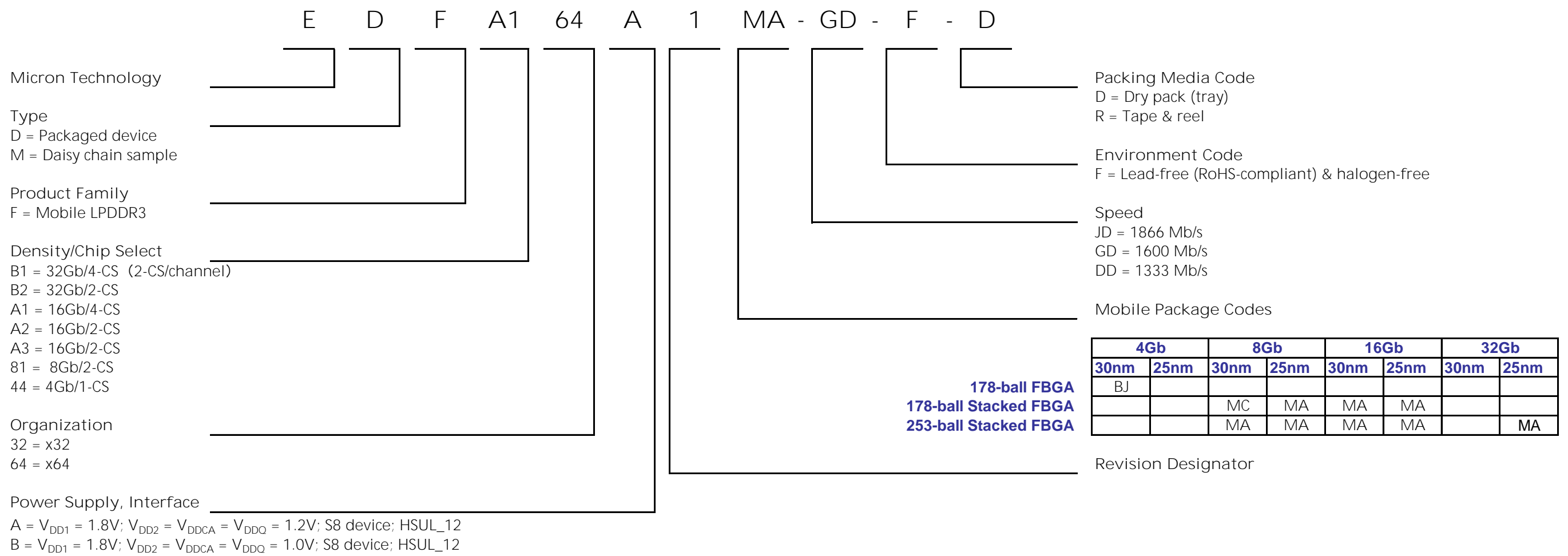

Rev. August 14, 2015

© 2015 Micron Technology, Inc.
 Micron and the Micron logo are trademarks of Micron Technology, Inc.
 Products and specifications are subject to change without notice. Dates are estimates only.



Legacy LPDRAM Part Numbering System

The part numbering system is available at www.micron.com/numbering

Legacy LPDDR2 PoP

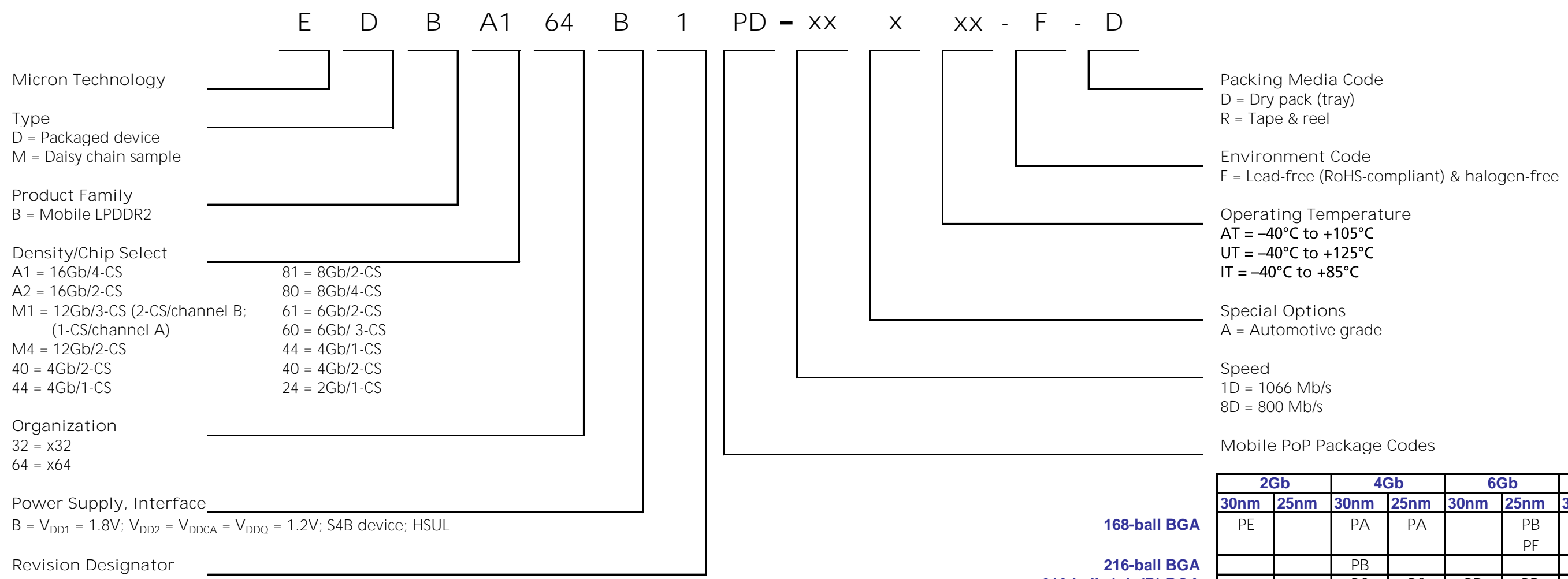

Packing Media Code

D = Dry pack (tray)
R = Tape & reel

Environment Code

F = Lead-free (RoHS-compliant) & halogen-free

Operating Temperature

AT = -40°C to +105°C
UT = -40°C to +125°C
IT = -40°C to +85°C

Special Options

A = Automotive grade

Speed

1D = 1066 Mb/s
8D = 800 Mb/s

Mobile PoP Package Codes

	2Gb		4Gb		6Gb		8Gb		12Gb	
	30nm	25nm	30nm	25nm	30nm	25nm	30nm	25nm	30nm	25nm
168-ball BGA	PE		PA	PA			PB	PB		PB
							PF	PP		PF
216-ball BGA			PB				PF			
216-ball -1ch (B) BGA			PC	PC	PD	PD	PD	PD		PD
							PH			
220-ball BGA			PP		PB	PF	PD	PF	PP	PD
							PH			
240-ball BGA			PD							

Rev. February 29, 2016

© 2014 Micron Technology, Inc.
Micron and the Micron logo are trademarks of Micron Technology, Inc.
Products and specifications are subject to change without notice. Dates are estimates only.



Legacy LPDRAM Part Numbering System

The part numbering system is available at www.micron.com/numbering

Legacy LPDDR2 FBGA

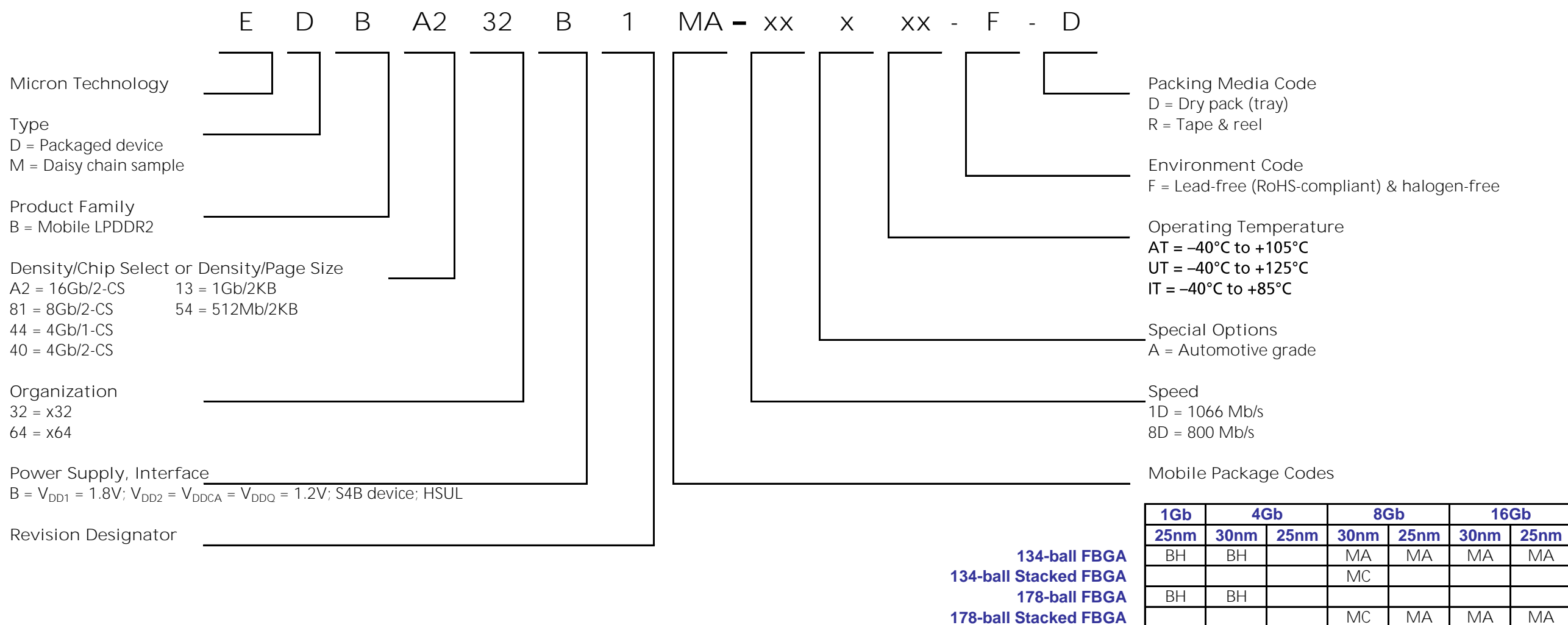

Legacy LPDRAM Part Numbering System

The part numbering system is available at www.micron.com/numbering

Legacy LPDDR3 and LPDDR2

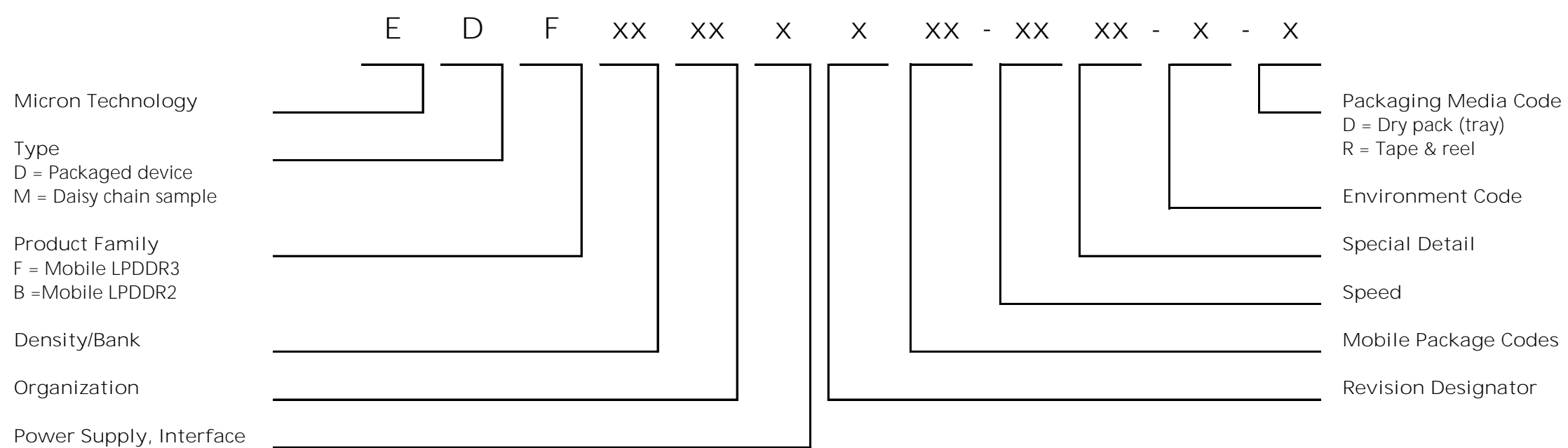

Rev. August 14, 2015

© 2014 Micron Technology, Inc.
Micron and the Micron logo are trademarks of Micron Technology, Inc.
Products and specifications are subject to change without notice. Dates are estimates only.

